

ES MANUAL DE UTILIZACIÓN
EN GUIDE TO INSTALLATION
FR GUIDE D'UTILISATION
DE BETRIEBSANLEITUNG
PT GUIA DE UTILIZAÇÃO

Placa de cocción
Cooking Hob
Table de cuisson
Kochfeld
Placa de cozinha

FAGOR 

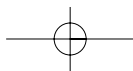
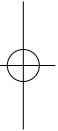
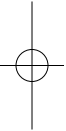
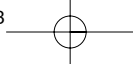

¿Quiere saber cómo funciona su placa?
Aquí tiene la respuesta



MANUAL DE INSTALACIÓN Y USO DEL APARATO

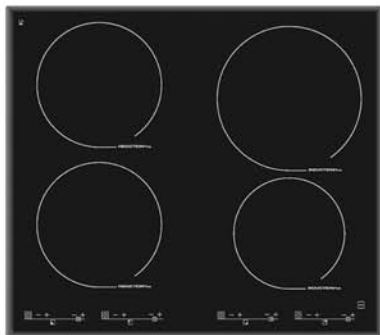

Do you want to know how
your hob plate works?
Here's your answer.



APPLIANCE INSTALLATION AND USAGE MANUAL

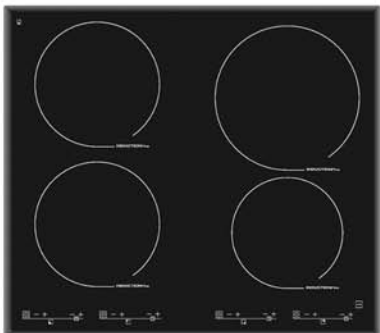

COMMIT TO ECOLOGY, RECYCLING AND PACKAGING WITH US

We work to protect the Environment.

For this reason, our packaging:

- Is 100% recyclable.
- Has the smallest possible amount of parts and material to make recycling easier.

WARNING

- Only the Authorised Technical Service can replace your hob plate if it breaks down. Otherwise your guarantee will not be valid.
- The nameplate features the technical and identification data for the appliance.
- This manual must be consulted before making any electrical connections.
- The electrical connections must be made by a specialist who is aware of the legal procedures and the standard requirements in each country.
- In order to constantly improve our products, we reserve the right to make technical evolution modifications to their technical, functional or aesthetic features.

INDUCTION HOBS

INDEX

INSTALLATION	4
1. DESCRIPTION OF THE APPLIANCE	4
2. FRAME DIMENSIONS	4
3. FASTENING THE WORKTOP	6
4. INSTALLATION POSITION	6
USE	7
1. TYPE OF APPLIANCE	7
•Power of each hob	7
2. DESCRIPTION OF THE COMMANDS	8
• <u>Command with special functions</u>	8
-Funciones	8
• Operation	9
-Switching on a hob	9
-Timer function	10
-Acoustic signal	10
• Special Functions	11
• <u>Command with basic functions</u>	13
• Operation	13
-Switching on a hob	13
-Timer function	13
-Acoustic signal	13
-P. function (P point)	
Fast heating function	13
• <u>Compact command</u>	14
• Operation	14
-Switching on a hob	14
-Acoustic signal	14
-Timer function	14
3. SAFETY	15
•Safety in operation	16
4. CONTAINERS	17
5. CARE AND CLEANING	18
6. ELECTRICAL CONNECTION	19
TROUBLESHOOTING	21

INDUCTION HOBS

INSTALLATION

1 DESCRIPTION OF THE APPLIANCE

- A** Air inlet
- B** Air outlet
- C** Vitroceramic glass
- D** Power cable

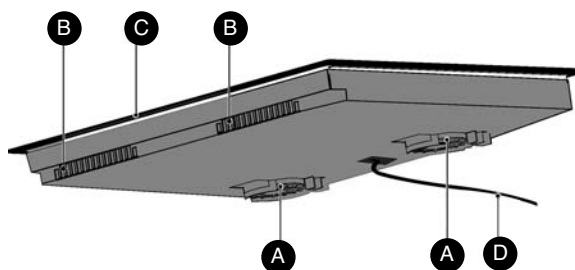

2 FRAME DIMENSIONS

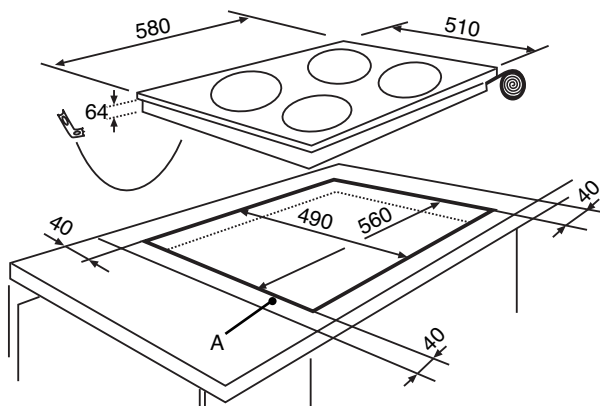

Your appliance must be positioned so that the electricity network installation is accessible. The distance between the edge of the hob plate and the side or rear wall (or panel) must be at least 40 mm (zone A).

Glue the foam joint underneath the hob plate following the outline of the support surfaces with your worktop. In this way you will get good sealing against the worktop. Fix the hob plate's hooks to the unit.

Do not use material which cannot be removed such as silicon.

FRAME DIMENSIONS

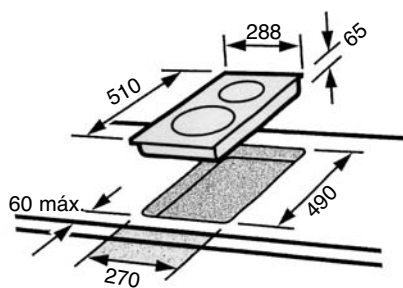
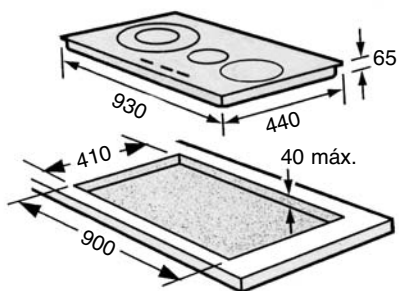
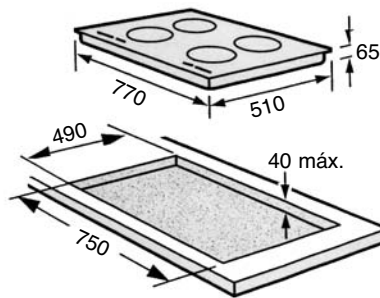
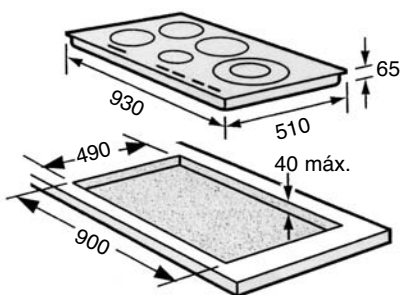

3 FASTENING TO THE WORKTOP

A Fit the hob into the space in the unit pressing down well to close the seal properly.

B Fix the four hob plate hooks underneath in the unit space corners.

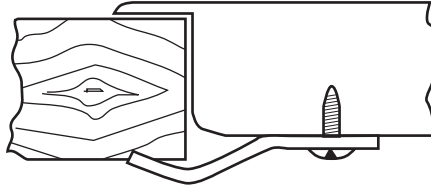

4 INSTALLATION POSITION

There must be a current of fresh air to cool your induction hob's electronics circuits as shown in the diagram.

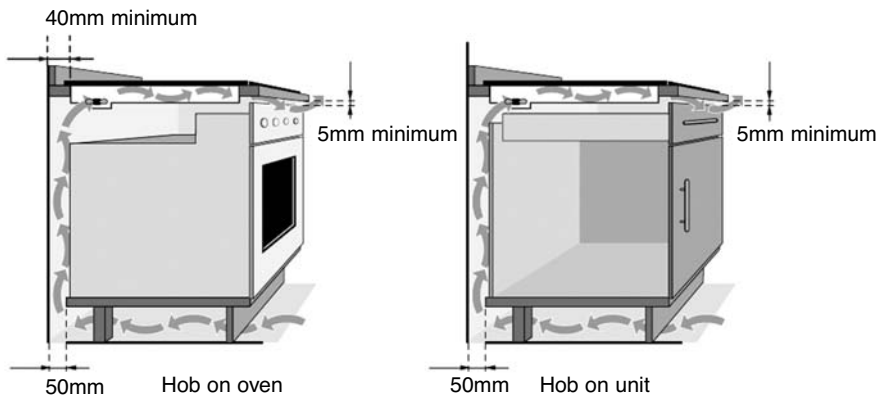

IMPORTANT

Installation must guarantee that fresh air can come from the rear and that a vent measuring at least 5 mm allows the air to escape in the front part.

USING INDUCTION HOBS

USE

1 TYPE OF APPLIANCE

TYPE A

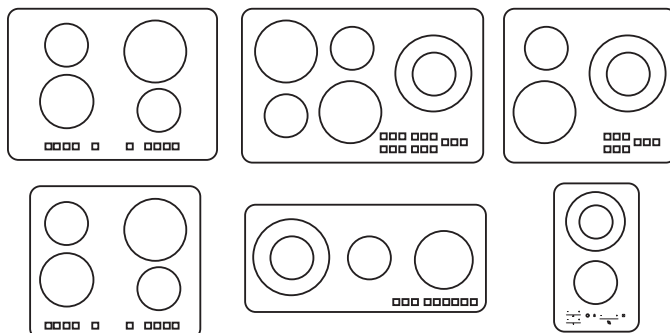

Type "A" appliances have commands with special functions or with basic functions

TYPE B

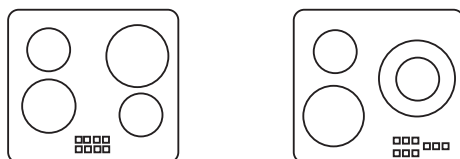

Type "B" appliances have compact commands

POWER OF EACH HOB

Hob size (cm)	Type "A" power	Type "B" power
16	2.200w	2.000w
18	2.800w	2.800w
21	3.100w	3.100w
28	3.600w	2.800w

2

DESCRIPTION OF THE COMMANDS

Find the type of command which corresponds to your hob

- . Command with special functions
- . Command with basic functions
- . Compact command

COMMAND WITH SPECIAL FUNCTIONS

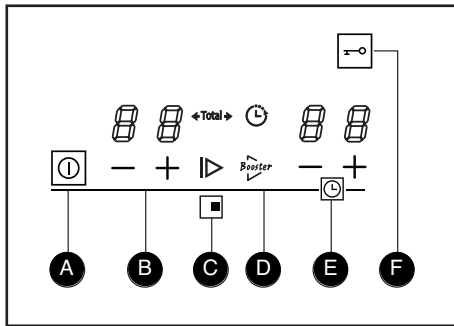

- A** On/Off Sensor
- B** Power sensors and displays between "0 and P"
- C** Indicator of Hob to use.
- D** Special functions.
- E** Timer sensors and display
- F** Safety sensor and display.

FUNCTIONS



Switches each hob on or off.
When the hob is switched on "0" appears on the power display.



Allows you to choose the power for any of the hobs from 0, 1, 2...11 and P.



Allows you to see the situation of each hob on the top.



Allows you to carry out special functions.

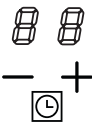

Allows you to select the cooking time for the chosen hob between 0 and 99 minutes. If we press "-" and "+" at the same time, the timer is set to 0. If these buttons are held down the minutes increase at a faster rate.



Allows the other sensors to be blocked to prevent children playing with them.

OPERATION

SWITCHING ON A HOB

- A** Put your fingertip over the on/off sensor. Remember that there is a safety sensor to prevent children playing with the controls, which is deactivated by holding your finger on the sensor for three seconds.



- B** Make sure that the sensor you are going to activate corresponds to the hob that you wish to use. Put your fingertip on the “-” or “+” power sensors.

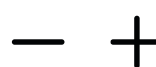

- C** Select the appropriate power level by holding your finger down.

IMPORTANT

- Whenever you wish you can activate the safety sensor by holding your finger over it for three seconds.
- If you leave an object on top of the sensors, the hob top will beep and switch off.
- The hob top switches off automatically after an estimated safety time, which varies according to the power level you have selected. (From 1 hour at power level “P” or “9”, up to 10 hours at power level “1”).

IMPORTANT

When boiling liquids, particularly using high power levels, you will hear a buzzing sound due to the hob frequency coupling.

TIMER FUNCTION

Steps to set a hob timer:

- A** Switch on a hob. To switch on the hob, press the  button on this hob. Then select the power you wish with the “+” or “-” buttons for the power sensors.

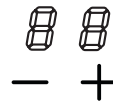

- B** Assign a time to the timer. To do this, press the “+” or “-” button on the timer, and it shows the time in minutes. If you start with “+” it will initially display “00” minutes.

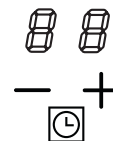

If you start with “-” it will initially display “99” minutes.

- C** This time will count down until it reaches zero and then the hob will switch off.

IMPORTANT

If no time is selected and the display shows 00, the timer will switch off, and if it indicates 99, it will take 99 minutes as its timer time.

ACOUSTIC SIGNAL

It is possible to silence the appliance, or deactivate the acoustic signals. They can only be activated or deactivated when the hob top is switched off.

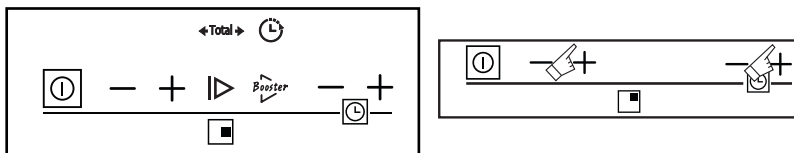

- In order to deactivate the acoustic signal, press simultaneously on the “+” power commands and “+” for the timer commands on the keypad for the right or rear right cooking zone (depending on the model) until the “bE Ep” symbol appears, keep pressing until the digits disappear.
- In order to activate the acoustic signal, press simultaneously on the “+” power commands and “+” timer commands on the keypad for the right or rear right cooking zone (depending on the model) until the “bE Ep” symbol appears, and an acoustic signal sounds, then stop pressing the buttons.

SPECIAL FUNCTIONS





Allows you to access a determined power level at any moment

Press the button  and the hob will heat up to a determined power level (The power level defined by the manufacturer is 8), but the user can change the value of this power level by following these steps.



Modification of the direct access power

(With the hob switched off)

1. Keep the button  pressed down until a beep sounds.
2. The power level which has been defined will flash on the display.
3. Modify the power level with the “-” and “+” power buttons (B).
4. Press the button  again to validate the operation.



This allows you to always be able to trip the power for a certain time. This gives the user total flexibility.

1. Start with the hob switched on and a determined power level.
2. Press the button  and then you can enter the new power level and the time which it is going to be active.
The power level is adjusted with the “-” and “+” buttons in zone (B) and the duration is adjusted using the “-” and “+” buttons in zone (E).
3. Then validate by pressing the button .
4. The new power level is displayed with a dot.
5. Once the time has passed, return to the initial position and the dot will disappear.



The cooking areas are equipped with a “BOOSTER” function. This function means that the maximum temperature can be obtained quickly.

1. Press the button 
The hob power display will display (bo) and the hob will start to give maximum power.
2. Once the hob has heated up, select the chosen power level by pressing the “-” button in zone “B”.

The “BOOSTER” function will be cancelled by pressing any other power sensor associated with the hob, or with the on/off sensor.







IMPORTANT

By using the “BOOSTER” function, if the other hob is switched on the same side of the hobplate, the maximum power level which can be used is 6. This is due to the fact that in this function the appliance takes power from the adjacent hob.



OFFSET PROGRAMMING

This allows you to adjust the finishing time and the duration of this cooking session.

1. Switch on the hob of your choice, using the  button.
2. Press the  button and it will display the current time. If the time is correct, go to point 4, and if not, adjust the time.
3. **ADJUSTING THE CURRENT TIME:** Use the “-” and “+” power buttons in zone (B) to change the hour and use the “-” and “+” timer buttons (E) to adjust the minutes.
4. Validate the time by pressing the  button (the digits will then flash).
5. Adjust the time to when you wish cooking to finish with the “-” and “+” buttons from zones (B) and (E).
6. Validate by pressing the  button.
7. Adjust the cooking time using the “-” and “+” buttons in zone (E).
8. Validate by pressing the  button
9. Define the chosen power level for cooking with the “-” and “+” buttons from zone (B).
10. Validate the power by pressing the  button.
11. Once programmed, it displays (Auto) and then the digits go off and only a red dot remains lit.

IMPORTANT

Offset programming cannot be used at the same time on more than one hob. The chosen finishing, duration and power values must be changed whilst the digits are flashing.

COMMAND WITH BASIC FUNCTIONS

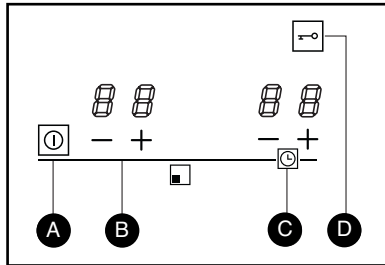

- A** On/Off sensor.
- B** Power sensors and displays between 0 and P.
- C** Timer sensors and displays.
- D** Safety sensor and display.

OPERATION

SWITCHING ON A HOB

The operation is the same as described for the commands with special functions.

TIMER OPERATION

The operation is the same as described for the commands with special functions.

ACOUSTIC SIGNAL

The operation is the same as described for the commands with special functions.

P. FUNCTION (P point) (Fast heating function)

This function allows greater power to be obtained during a certain time.

- The "P." function (P point) is obtained by pressing the "+" button as far as the "P." position, release the command and the "P." will flash, press the command again and it will be put in the maximum power "P." position (P point) then press the "-" command and enter in the chosen cooking time. It will then display "P." (P point).

When the relevant time has passed, the power selected by the user will return.

IMPORTANT

After selecting the power "P." (P point), if you do not choose the final working power, the hob power will be maintained at "P."

Whilst "P." is displayed (P point) any action on the power commands will cancel the "fast heating function" and it will return to the classic power regulation mode

WARNING

Preferably use cooking zones situated on different sides. If you choose them on the same side, using the cooking zone at maximum power limits the other cooking zone, situated on the same side which is visible in the power indicators.

COMPACT COMMAND

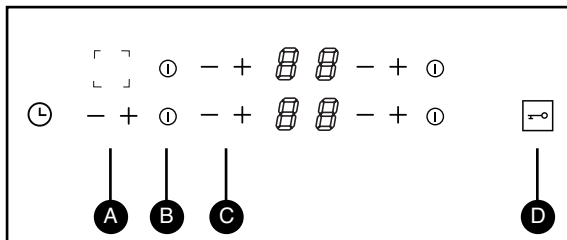

- A** Timer sensors and display
- B** On/Off sensor
- C** Power sensors and displays from "0" to "9"
- D** Safety sensor and display

OPERATION

SWITCHING ON A HOB

The operation is the same as described for the commands with special functions.

ACOUSTIC SIGNAL

The operation is the same as described for the commands with special functions.

TIMER FUNCTION

Steps to follow to time a hob:

- A** Switch on a hob. In order to switch the hob on, press the ⓘ button for this hob. Then select the chosen power level using the "+" or "-" buttons on the power sensors.
- B** Switch on the timer. For this purpose, press ⌚. The zone you wish to time is displayed using these symbols.
- C** If you press repeatedly on ⌚, the hob position will rotate.
- D** Once the hob to time has been selected, the time is assigned using the "+" or "-" timer buttons. This will display the time in minutes. If you start with "+" the display will initially read "00" minutes. If you start with "-" the display will initially read "99" minutes.
- E** This time will count down until it reaches zero and then the hob will switch off.

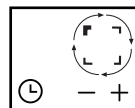

IMPORTANTE

Only one hob can be timed at once. To stop timing, press the button ⌚. The hob which is timed will alternately display the working power and a "t".

3 SAFETY

The danger of burning yourself due to the temperature of the glass is minimal. As the heat is produced in the recipient itself, the glass does not heat up very much.

Induction hobs have a recipient detection system. This means that the hob will not work unless there is an appropriate recipient on it.

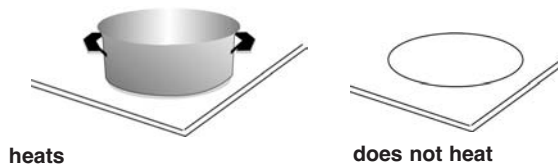

Boiling water

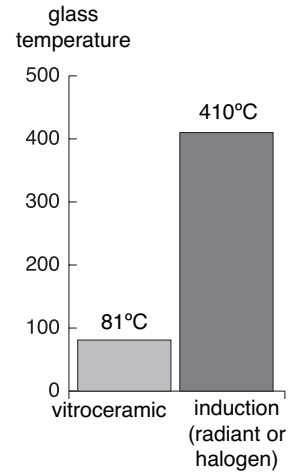

IMPORTANT

WARNING FOR USERS WITH PACEMAKERS AND ACTIVE IMPLANTS:

The worktop operation complies with standards in force regarding electromagnetic perturbations.

Your induction cooking hob plate completely meets the legal requirements (directives 89/336/CEE). It has been designed not to interfere in the operation of other electrical appliances in so far as they also meet the same standard.

YOUR INDUCTION HOB GENERATES MAGNETIC FIELDS CLOSE BY.

So that there is no interference between your cooking worktop and a pacemaker, it is necessary for the pacemaker to be designed in compliance with the relevant standard. As far as the compliance of the pacemaker is concerned, or possible incompatibilities, you can consult its manufacturer or your doctor.

OPERATION SAFETY

RESIDUAL HEAT

After intense use, the cooking area which you have just used can continue to be hot for a few minutes.

A flashing "H" will appear whilst it is hot. Do not touch these areas.

PROTECTION IN THE EVENT OF SPILLAGE

In the event of overflow, the hob will stop and a symbol will appear as shown in (Fig. A), and a warning beep (depending on the model) can be activated in any of the following three cases.

1. Spillage covering the command keypad.
2. Wet clothe over the keypad .
3. Metal object on the command keypad.

Clean or remove the object and start cooking again.

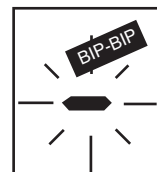

(Fig.A)

AUTO-STOP SYSTEM

If you forget to switch off a hob, your hob plate is equipped with an AUTO-STOP SYSTEM safety function which will automatically cut off the cooking area after a set time (between 1 and 10 hours depending on the power being used).

In the event that this safety function is activated, the power cut off in the cooking zone will be indicated by "AS" or "A" displayed in the command area and a warning beep will sound for a few minutes. Press any key on the command pad to stop the warning sound. A double beep will confirm this command.

Induction heat is generated very quickly and on the base of the recipient itself. For this reason, an empty recipient should never be heated on the hob.

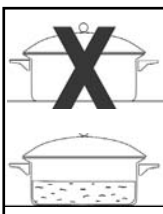

Try not to move the recipients by pulling them over the glass on the plate. Lift them to move them.



Among recipients which are valid for induction, it is preferable to use thick based pans as they distribute and use the heat better.

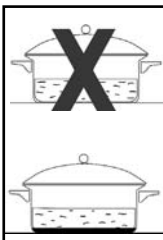

Do not leave utensils on the hob when it is on. It can detect them as recipients and heat them.



Normally, a spoon or fork will not be detected but a larger utensil will be.



4 RECIPIENTS

If the recipient is not appropriate, the power indicator will flash. Only glass, clay, aluminium without a special base, copper and some non magnetic stainless steels are not suitable for induction cooking.

WHICH COOKING AREA SHOULD I USE FOR EACH RECIPIENT?

Cooking area*	Recipient to use
16 cm	10...18 cm
18 cm	12...22 cm
21 cm	18...24 cm
28 cm	12...32 cm

*Depending on the model

5 CARE AND CLEANING

As the glass heats up much less, this means that the splashes or spills do not harden on the hob plate. So cleaning is much easier.

However, both vitrocermic and induction hobs should be cleaned as quickly as possible after splashes and spills.



Lighter dirt can be removed simply with kitchen paper or a cloth.

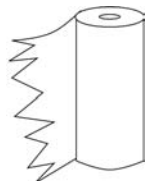

For more resistant dirt, use specific products for vitroceramic glass.

Follow each product's instructions .



IMPORTANT

- Do not use abrasive products or scrubbing powder. You could scratch the plate.
- Do not use a steam cleaner .
- If a crack appears on the surface of the glass, disconnect the appliance immediately from the electrical power source. Do not use any part of the plate before installing a new vitroceramic glass plate.

6

ELECTRICAL CONNECTION

3 WIRE CABLES

220-240 V single phase

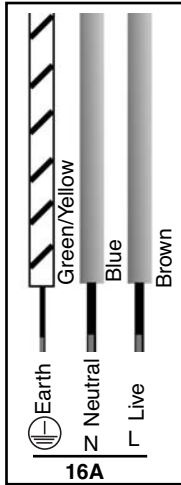

16 amp fuse

400 V 3N three phase

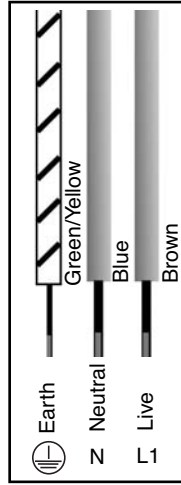

16 amp fuse

5 WIRE CABLES

220-240 V single phase

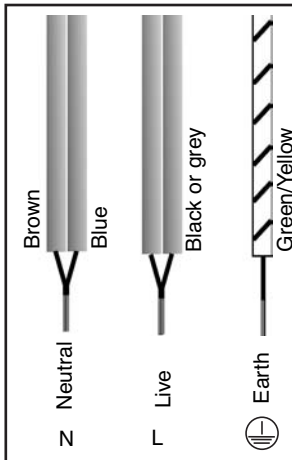

32 amp fuse

400 V 2N 3-phase

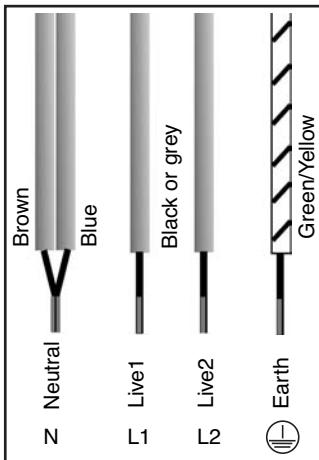

16 amp fuse

Separates the 2 live cables L1, L2 before making the connection.

2 x 230 V three phase

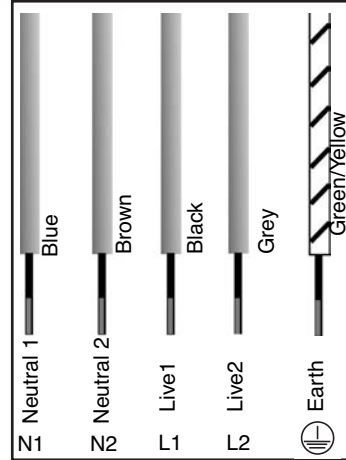

Separates the 2 live cables L1, L2 and Neutral N1 N2 before making the connection.

CABLES DE 8 HILOS

220-240 V single phase

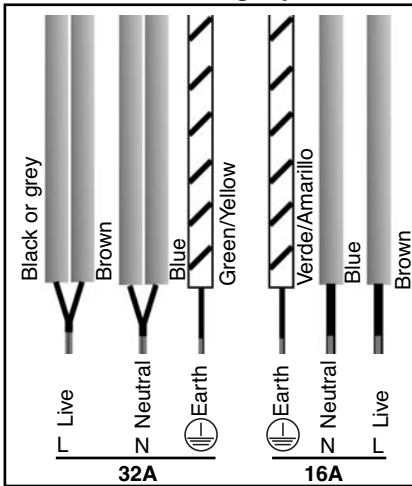

16 and 32 amp fuses

220-240 V single phase

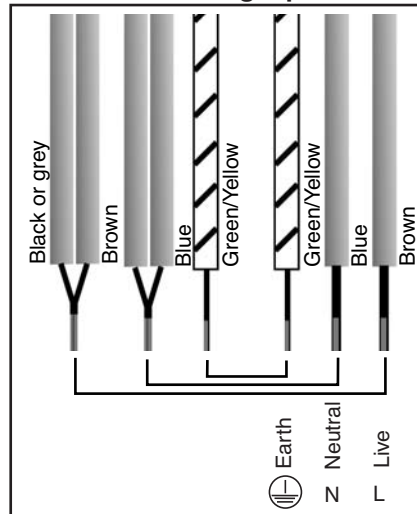

400 V 3N 3-phase

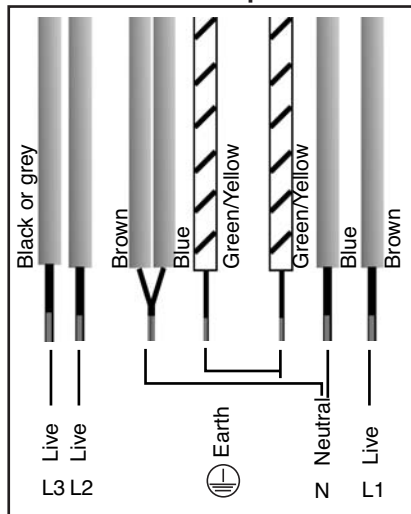

Separates the 2 live cables L1, L2 before making the connection.

IMPORTANT

The hob plate is provided with a power cable. If the power cable is damaged it must be replaced by the manufacturer, after sales service or authorised personnel in order to avoid danger.

When switching the hob plate on for the first time or after a long time without use, a code will light up on the command panel.

TROUBLESHOOTING

YOU FIND THAT	POSSIBLE CAUSES	WHAT TO DO
The induction plate does not work. The lights on the keypad are off.	The appliance is not receiving any power. The power supply or connection is faulty.	Check the electrical installation.
Trip switches are activated when you switch it on.	Connection to your hob plate is faulty.	Check fuses and trip switches.
When you connect the appliance to the network a light appears.	Normal operation.	Check connection conformity.
The plate gives off a smell when you cook on it for the first few times.	New appliance	Nothing, the message will disappear after 30 seconds.
The plate does not work and a message appears.	The electronics circuit does not work properly.	Heat a pan of water on each hob for 1/2 hour.
The plate does not work and this information appears OL	The plate is locked.	Ring the Technical Service. See child safety chapter.
The plate stops working, it beeps every 10 seconds and — or F7 appears on screen.	There has been an overflow or an object is obstructing the command panel.	Clean or remove the object and start cooking again.
This type of symbol — or F7 appears.	The electronic circuits have overheated.	See framing chapter.
After switching on a hob, the keypad lights continue to flash.	The recipient used is not suitable for induction or its diameter is less than 12 cm (10 cm on 16 cm hob).	See chapter on recipients for induction.
Pans make a noise during cooking. The hob plate makes crackling noises during cooking.	Normal with some types of recipients. This is due the energy passing from the plate to the recipient.	Nothing. There is no risk for the plate or the recipient.
The ventilation continues for a few minutes after switching off the hob plate.	Cooling the electronics. Normal operation.	Nothing.

ENVIRONMENTAL WARNINGS

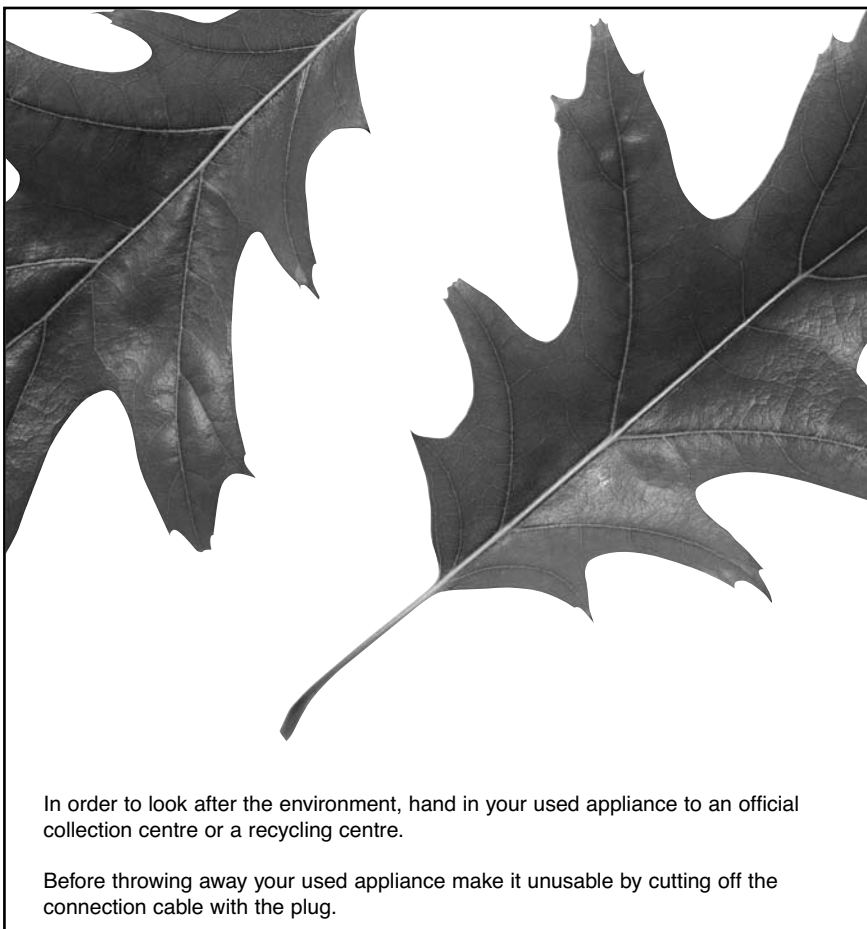

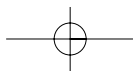
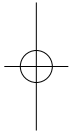
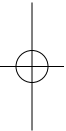
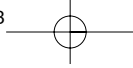

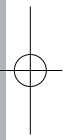
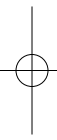

03-07



Printed on recycled paper

C60T376A8

