

# **INSTRUCTIONS FOR USE**

**BEFORE USING THE APPLIANCE**

**SAFEGUARDING THE ENVIRONMENT**

**PRECAUTIONS AND GENERAL  
RECOMMENDATIONS**

**HOW TO USE THE REFRIGERATOR  
COMPARTMENT**

**HOW TO USE THE FREEZER COMPARTMENT**

**HOW TO DEFROST THE FREEZER  
COMPARTMENT**

**HOW TO CLEAN THE REFRIGERATOR  
COMPARTMENT**

**CARE AND MAINTENANCE**

**TROUBLESHOOTING GUIDE**

**AFTER-SALES SERVICE**

**INSTALLATION**

**ELECTRICAL CONNECTION**

**3FIC370 FRIDGE FREEZER**

## BEFORE USING THE APPLIANCE

- Your new appliance is designed exclusively for domestic use

**To get the most out of your new appliance, read the user handbook thoroughly. The handbook contains a description of the appliance and useful tips for storing food. Keep this handbook for future consultation.**

- After unpacking, make sure that the appliance is undamaged and that the door closes properly. Any damage must be reported to your dealer within 24 hours after delivery of the appliance.
- Wait at least two hours before switching the appliance on in order to ensure the refrigerant circuit is fully efficient.
- Installation of the appliance and electrical connections must be carried out by a qualified electrician, in accordance with the manufacturer's instructions and local safety regulations
- Clean the inside of the appliance before using it.

## SAFEGUARDING THE ENVIRONMENT

### 1. Packing

The packaging material is entirely recyclable, and marked with the recycling symbol. Follow local regulations for scrapping. Keep the packaging materials (plastic bags, polystyrene parts, etc.) out of reach of children, as they are potentially dangerous.

### 2. Scrapping

The appliance is manufactured using recyclable material.

This appliance is marked according to the European directive 2002/96/EC on Waste Electrical and Electronic Equipment (WEEE). By ensuring this product is disposed of correctly, you will help prevent potential negative consequences for the environment and human health, which could otherwise be caused by inappropriate waste handling of this product.

The symbol  on the product, or on the documents accompanying the product, indicates that this appliance may not be treated as household waste. Instead it shall be handed over to the applicable collection point for the recycling of electrical and electronic equipment.

Before scrapping, make the appliance unusable by cutting off the power cable and removing the doors and shelves so that children cannot easily climb inside the appliance.

Disposal must be carried out in accordance with local environmental regulations for waste disposal. Deliver the appliance immediately to an authorized dump; do not leave it unattended even for a few days, since it is potentially dangerous for children. For more detailed information about treatment, recovery and recycling of this product, please contact your local city office, your household waste disposal service or the shop where you purchased the product.

### Information:

This appliance does not contain CFCs (replaced with R134a) or HFCs (replaced with R600a). Appliances with Isobutane (R600a): isobutane is a naturally occurring, low environmental impact gas. Caution is required, however, because isobutane is flammable. Therefore, it is essential to ensure that refrigerant pipelines are not damaged.

### Declaration of conformity

- This appliance is designed to store food and is manufactured in conformity with EEC directive No. 89/109/CEE, 90/128/CEE, 02/72/CEE.



- This appliance is designed, manufactured, and retailed in compliance with:
  - the safety objectives of the Low Voltage Directive 73/23/EEC;
  - the protection requirements of the "EMC" Directive 89/336/EEC, amended by Directive 93/68/EEC;
- The electrical safety of the appliance can only be guaranteed if the product is connected to an approved earth connection.



## PRECAUTIONS AND GENERAL RECOMMENDATIONS

- Use the refrigerator compartment only for storing fresh food and beverages and use the freezer compartment only for storing frozen food, freezing fresh food and making ice cubes.
- After installation, make sure that the appliance is not standing on the power supply cable.
- Do not store glass containers with liquids in the freezer since they may burst.
- Do not eat ice cubes or ice lollies immediately after taking them out of the freezer since they may cause cold burns.
- Before carrying out any maintenance or cleaning, always unplug the appliance or disconnect the power supply.
- Make sure that your appliance is not near a heat source.
- Do not store or use gasoline or other flammable vapours and liquids in the vicinity of this or any other appliance. The fumes can create a fire hazard or explosion.
- To ensure proper ventilation leave a 1 cm space on both sides and above the appliance.
- Ensure that the vent outlets on the appliance casing or housing unit are unobstructed in order to allow correct air circulation.
- All appliances equipped with an ice maker or water dispenser must be connected to a mains water supply that delivers potable water only (with water pressure between 1.7 and 8.1 bar (25 and 117 PSI)). Ice makers and/ or water dispensers not directly connected to a mains water supply must be filled with potable water only.
- Install and level the appliance on a floor strong enough to take its weight and in an area suitable for its size and use.

- Install the appliance in a dry and well-ventilated place. The appliance is set for operation at specific ambient temperature ranges, according to the climatic class indicated on the data plate: The appliance may not work properly if it is left for a long period at a temperature above or below the indicated range.

Climatic class	Amb. T. (°C)	Amb. T. (°F)
SN	From 10 to 32	From 50 to 90
N	From 16 to 32	From 61 to 90
ST	From 18 to 38	From 64 to 100
T	From 18 to 43	From 64 to 110

- Be careful not to damage the floors when you move the appliance (e.g. parquet flooring).
- Do not use mechanical devices or any means other than those recommended by the manufacturer to speed up the defrosting process.
- Do not damage the refrigerant circuit.
- Do not use electrical appliances inside the freezer compartments, unless such appliances are specifically recommended by the manufacturer.
- This appliance is not designed for use by young children or the infirm.
- To avoid the risk of children being trapped and therefore suffocating, do not allow them to play or hide inside the appliance.
- The power cable may only be replaced by an authorized person.
- Do not use extension leads or adapters.
- It must be possible to disconnect the appliance from the mains by unplugging it or by means of a two-pole switch fitted upline of the socket.
- Ensure that the voltage indicated on the appliance data plate corresponds to the domestic supply voltage.
- Do not ingest the contents (non-toxic) of the ice packs (if provided).

# HOW TO USE THE REFRIGERATOR COMPARTMENT

This appliance is a refrigerator with a 4 star  freezer compartment.

**Defrosting of the refrigerator compartment is performed automatically.**

The refrigerator can operate in room temperatures between +10° C and +38° C. Optimal performance of the appliance depends on the climatic class, which is indicated on the rating plate.

## Switching on the appliance

Plug in the appliance.

The thermostat knob in the refrigerator compartment serves to adjust the temperature in both the refrigerator and freezer compartment if your appliance is equipped with a single compressor.

Refrigerator compartment and freezer compartment temperature adjustment is independent in the case of appliances with two compressors (see product description sheet).

## Temperature adjustment

- To ensure correct operation and the best possible food storage in both compartments, **set the thermostat in accordance with the indications on the enclosed product description sheet.**
- To alter the temperature in the refrigerator and freezer compartments set the thermostat knob to:
  - lower numbers 1-2 (MIN)** if you want to **INCREASE** the temperature;
  - higher numbers 5-7 (MAX)** if you want to **DECREASE** the temperature.

Thermostat setting ● switches off all functions of the appliance including the interior light.

## Note:

The room air temperature, the number of times the door is opened and the position of the appliance will affect the temperature in the refrigerator and freezer compartments. Take these factors into consideration when you set the thermostat. For example if the machine is operated in a room with high temperature you may need to set the thermostat to a low number.

## Using the refrigerator compartment

Position the food as shown in the figure.

- A Cooked food
- B Fish, meat
- C Fruit and vegetables
- D Bottles
- E Butter
- F Dairy products, cheese

## Notes:

- The space between the shelves and the rear wall of the refrigerator compartment must be unobstructed to allow air circulation.
- Do not place the food in direct contact with the rear wall of the refrigerator compartment.
- Do not place hot food in the refrigerator.
- Store liquids in closed containers.
- Storage of vegetables with high water contents can lead to the formation of condensation: this will not affect the correct operation of the appliance.



# HOW TO USE THE FREEZER COMPARTMENT

The appliance has a 4 star  freezer compartment in which food can be stored for the time indicated on the packaging. The freezer can also be used to freeze fresh food by positioning it on the racks; place frozen food in the lower basket so that there is no contact with fresh food that has yet to be frozen. The quantity of fresh food that can be frozen in 24 hours is shown on the rating plate.

## Freezing fresh food

If your appliance is equipped with a single compressor:

- Set the thermostat knob to 2-3.
- If the appliance is equipped with a freeze button, press it to activate the function (the yellow indicator light will switch on). Also the red indicator light (models with control panel) may switch on. The red indicator light will switch off when the freezer compartment has reached the optimum temperature.

### Note:

The freeze function makes it possible to freeze fresh food while maintaining the temperature in the refrigerator compartment at the optimum level.

## Rapid freezing function

If your appliance is equipped with two compressors, activate the rapid freezing function 6 hours before inserting fresh food to obtain the maximum freezing power as indicated on the rating plate.

### Important:

- Before freezing, wrap and seal fresh food in: aluminium foil, cling film, air and water-tight plastic bags, polythene containers with lids or special freezer containers.
- Arrange the fresh food in the upper area of the freezer compartment, leaving sufficient space around each pack for the air to circulate.
- The food will be completely frozen in 24 hours.
- Press the rapid freezing button to switch off the function (yellow indicator light switches off).

## Temperature alarm function

(control panel versions)

When the appliance is running normally or when food is being frozen, the **red led** may switch on (in certain models this will be accompanied also by an **audible signal**) informing you that the temperature in the freezer compartment is too high.

This may occur in the following situations:

- when the appliance is switched on for the first time;
- when it is switched on following defrosting and cleaning;
- if you load too much food at room temperature;
- if the freezer door has been left ajar;
- if the "freezer thermostat knob" on the control panel is advanced towards the "**MAX**" setting (intense cold);

To mute the acoustic alarm press the "Fast freeze" button.

When temperature in the freezer compartment has fallen to acceptable levels, the red indicator LED will switch off automatically. At this point remember to switch off the "Fast freeze" function.



# HOW TO USE THE FREEZER COMPARTMENT

## Note:

The temperature in the freezer compartment is maintained at the ideal level for the storage of frozen food also during power failures of limited duration, although it is advisable to avoid opening the freezer compartment door during such periods.

## Important:

The table alongside shows the recommended maximum storage time for frozen fresh foods.

## When purchasing frozen food products:

- ensure that the packaging is not damaged (frozen food in damaged packaging may have deteriorated). Avoid packages that are swollen or show evidence of damp areas indicating that the food may have thawed partially during its period of storage.
- When shopping, leave frozen food purchases till last and transport the products in a thermally insulated cool bag.
- Place the items in the freezer compartment as soon as you get home.
- If food has thawed, even partially, do not re-freeze it. Consume within 24 hours.
- Avoid subjecting foods to temperature variations. Observe the "best before" date on the package.
- Always observe the storage information on the package.

## Removing the baskets

- Pull out fully, raise slightly and remove.

## Note:





The freezer compartment can be used without the two upper baskets to increase storage space for large products. The lower basket must not be removed.

Place the food products directly on the racks.

After inserting food, ensure that the freezer compartment door closes properly.

## Making ice cubes

- Pour water into the ice tray up to 2/3 full and place it in the freezer compartment.
- If the ice tray sticks to the shelves, do not use pointed or sharp objects to detach it.
- Bend the ice tray slightly to remove the cubes.

MONTHS	FOOD
2-3	
4-6	
6-8	
10-12	



## HOW TO DEFROST THE FREEZER COMPARTMENT

Before servicing or cleaning the appliance, unplug it from the mains or disconnect the electricity supply. Defrost the freezer compartment once or twice a year or when the formation of ice on the racks is excessive. It is perfectly normal for ice to form on the racks. The amount and speed at which the ice forms depends on room air temperature and humidity and the frequency with which the door is opened. Ice formation is concentrated on the racks at the top of the freezer compartment. If possible, defrost the freezer compartment when it is nearly empty.

- Remove the food from the freezer compartment, wrap in a newspaper and group together in a cool place or in a portable cooler.
- Leave the freezer door open so that the ice can thaw.
- Pull out the defrost water drain and place a tray below it.
- Clean the interior of the freezer compartment with a sponge and warm water and/or neutral detergent. Do not use abrasive products.
- Rinse the interior and dry thoroughly.
- Fit the drain back into place.
- Put the food back into the freezer compartment.
- Close the compartment door.
- Plug in the appliance / reconnect the electricity supply.
- Switch the appliance on.



## HOW TO CLEAN THE REFRIGERATOR COMPARTMENT

The refrigerator compartment must be cleaned periodically.

Defrosting of the refrigerator compartment is completely automatic.

Droplets of water on the rear wall of the refrigerator compartment indicate that the periodic automatic defrost cycle is in progress. The defrost water is routed to a drain outlet and into a container on the compressor from which it evaporates.

Clean the defrost water drain outlet regularly using the tool supplied with the appliance. This precaution ensures that defrost water is removed correctly from the interior of the refrigerator compartment.

Before cleaning the refrigerator compartment, unplug the appliance from the mains.

- Use a sponge with warm water and/or neutral detergent.
- Rinse the interior and dry with a soft cloth.

**Do not use abrasive products**



## CARE AND MAINTENANCE

### Prolonged disuse

1. Empty the refrigerator and freezer compartments.
2. Unplug the appliance from the mains.
3. Defrost and clean the interior of both compartments.
4. Leave the doors open to prevent the formation of mould, odours and oxidation.

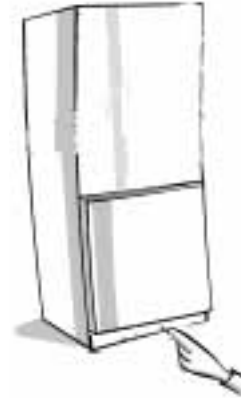

## TROUBLESHOOTING GUIDE

1. **The appliance is not working.**
  - Is there a power failure?
  - Is the plug properly inserted in the socket?
  - Is the mains power switch set to ON?
  - Has the fuse blown?
  - Is the power cord in perfect condition?
  - Is the thermostat knob on position ● (Stop)?
2. **Temperature is not low enough.**
  - Are the doors closed properly?
  - Is the appliance installed next to a heat source?
  - Is the thermostat setting correct?
  - Are the air circulation grilles blocked?
3. **Temperature is too low.**
  - Is the thermostat setting correct?
4. **Water collects at bottom of refrigerator compartment.**
  - Is the defrost water drain outlet blocked?
5. **The interior light is not working.**

Perform the checks for problem 1, and then:

  - Unplug the appliance. To access the bulb, refer to the instructions and illustration on the attached product description sheet.
  - Check the bulb and, if necessary, replace it with an equivalent one (15 W max.).
6. **Red LED on freezer control panel remains lit / acoustic alarm sounds.**

(see How to use the freezer compartment)

  - Have you just loaded a large quantity of fresh food?
  - Freezer door properly closed?

### Notes:

- **The front edge of the appliance may be hot. This prevents the formation of condensation and is not a defect.**
- **Gurgling and hissing noises due to expansion in the refrigerant circuit are normal.**

## AFTER-SALES SERVICE

### Before calling After-sales Service:

1. See if you can solve the problem yourself with the help of the Troubleshooting Guide.
2. Switch the appliance on again to see if the problem persists. If it does, switch off and wait for about an hour before switching on.
3. If the problem persists after this action, contact After-sales Service.

### Specify:

- the nature of the fault,
- the model,
- the service number (the number after the word SERVICE on the rating plate on the inside of the appliance),
- your full address,
- your telephone number and area code.

**SERVICE** 0000 000 00000



### Note:

The direction of door opening can be changed. If this operation is performed by After-sales Service it is not covered by the warranty.

## INSTALLATION

- Install the appliance away from heat sources. Installation in a hot environment, direct exposure to the sun or installation near heat sources (heaters, radiators, cookers) will increase power consumption and should therefore be avoided.
- If this is not possible, the following minimum distances must be respected:
  - 30 cm from coal or paraffin stoves;
  - 3 cm from electric or gas cookers.
- Install the appliance in a dry, well-ventilated place.
- Clean the interior (see the relative heading in this handbook).
- Fit the accessories.

### Electrical connection

- **Electrical connections must be made in accordance with local regulations.**
- Voltage and power consumption are indicated on the rating plate inside the appliance.
- **The appliance must be earthed by law. The manufacturer declines all liability for injury to persons or animals and for damage to property resulting from failure to observe the above prescriptions.**
- If the plug and socket are not of the same type, have the socket replaced by a qualified electrician.
- Do not use extension leads or adaptors.

### Disconnecting the appliance

It must be possible to disconnect the appliance by unplugging it or by means of a two-pole switch fitted upline of the socket.

# ELECTRICAL CONNECTION

## 1) For Great Britain only

**Warning - this appliance must be earthed**

### Fuse replacement

If the mains lead of this appliance is fitted with a BS 1363A 13amp fused plug, to change a fuse in this type of plug use an A.S.T.A. approved fuse to BS 1362 type and proceed as follows:

1. Remove the fuse cover (A) and fuse (B).
2. Fit replacement 13A fuse into fuse cover.
3. Refit both into plug.

### Important:

The fuse cover must be refitted when changing a fuse and if the fuse cover is lost the plug must not be used until a correct replacement is fitted.

Correct replacement are identified by the colour insert or the colour embossed in words on the base of the plug.

Replacement fuse covers are available from your local electrical store.

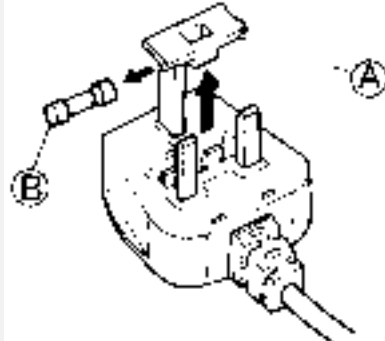

## 2) For the Republic of Ireland only

The information given in respect of Great Britain will frequently apply, but a third type of plug and socket is also used, the 2-pin, side earth type.

## 3) Socket outlet / plug (valid for both countries)

If the fitted plug is not suitable for your socket outlet, please contact Whirlpool Service for further instruction. Please do not attempt to change plug yourself. This procedure needs to be carried out by a qualified Whirlpool technician in compliance with the manufactures instructions and current standard safety regulations.